

PROJECT	_____
TYPE	_____
SPECIFIER	_____
QUANTITY	_____
DATE	_____

## MINI SS - DRIVE OVER RECESSED

### E91254-

base number Color Lens  
Temperature Options

- To build a product code in our configurator select the specify button on the base model # product page
- To build a manual product code on this datasheet choose from the options listed below in blue font and add the suffix to the base model #

#### GENERAL

Series: Mini  
Subseries: Mini SS - Drive Over  
Brand: Platak  
Division: Exterior  
Mounting Type: Recessed  
Mounting Location: In-Ground  
Subcategory: Drive Over

#### PHYSICAL

Shape: Round  
Diameter (mm): 152  
Diameter (in): 6  
Depth (mm): 80  
Depth (in): 3 1/8  
Light Distribution: Uplight  
Weight (kg): 1.5  
Weight (lbs): 3.3  
Load Resistance (kg): 2500  
Load Resistance (lbs): 5511  
Installation Requirement: Installation with L9A08800 sleeve set in concrete requires a 20-30 cm gravel drain bed  
Screws: A4 stainless steel  
Diffuser: Clear tempered glass  
Fixture Finish: SST  
Fixture Material: Aluminum Die Cast  
Cable Details: Supplied with 1 power cable 1m in length

#### ELECTRICAL

Lamp Type: LED  
Input Wattage (W): 10.5  
Total Output Wattage (W): 9  
Dimming: Tri-Mode (Non-Dimming and Phase Dimming (120Vac only) and 0-10V Dimming)  
Driver Included: No  
Driver Location: Remote  
Driver Type: Constant Voltage - 120 / 277Vac  
Driver Class: Class 2  
Input Voltage (V): 120 - 277  
Constant Current (MA): 500

#### LED

Number of LEDs: 6  
Color Temperature (°K): 3000 / 4000  
Max. Delivered Lumen (lm): 775 - 955 / 805 - 995  
Nominal Lumen (lm): 1140 / 1200  
CRI: >80 CRI  
Lamp Life (hrs): 60000

#### OPTICAL

Optic°: 9 / 28 / 44  
Adjustability: Tilt ±5°

#### RATINGS AND CERTIFICATIONS

Certified By: Certified for North American Standards  
IP rating: IP68  
IK Rating: IK10  
Bug Rating: B0 U4 G0



140mm 5 1/2"

85mm 3 3/8"

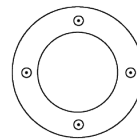

80mm 3 1/8"  
97mm 3 13/16"

140mm 5 1/2"

85mm 3 3/8"

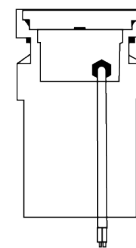
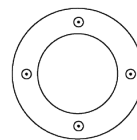

80mm 3 1/8"  
230mm 9 1/16"



## MINI SS - DRIVE OVER RECESSED

E9I254-

PROJECT	_____
TYPE	_____
SPECIFIER	_____
QUANTITY	_____
DATE	_____



## MINI FULL INOX RECESSED

### E9I576-

base number            Color            Lens             
 Temperature            Options           

- To build a product code in our configurator select the specify button on the base model # product page
- To build a manual product code on this datasheet choose from the options listed below in blue font and add the suffix to the base model #

#### GENERAL

Series: Mini  
 Subseries: Mini Full Inox  
 Brand: Platek  
 Division: Exterior  
 Mounting Type: Recessed  
 Mounting Location: In-Ground  
 Subcategory: Drive Over

#### PHYSICAL

Shape: Round  
 Diameter (mm): 152  
 Diameter (in): 6  
 Height (mm): 80  
 Height (in): 3 1/8  
 Light Distribution: Uplight  
 Load Resistance (kg): 2000  
 Load Resistance (lbs): 4409  
 Installation Requirement: Installation in sleeve set in concrete with a 20-30 cm gravel drain bed  
 Screws: A4 stainless steel  
 Diffuser: Clear tempered glass  
 Fixture Finish: SST  
 Fixture Material: Stainless Steel  
 Cable Details: Supplied with 1 power cable 0.5m in length

#### ELECTRICAL

Lamp Type: LED  
 Input Wattage (W): 11  
 Total Output Wattage (W): 10  
 Driver Included: No  
 Driver Location: Remote  
 Driver Type: Constant Voltage - Universal  
 Housing: (Not included - see components) L9A08800 allows for external driver (non-dimming - 120 / 277Vac) / L  
 Input Voltage (V): 120 - 277  
 Output Voltage (V): 24  
 Upon Request: (Not included - see components [IP65 or higher enclosure to be supplied by others]) 0-10Vdc dimming / Phase dimming / Non-dimming 120/277Vac

#### LED

Number of LEDs: 6  
 Color Temperature (°K): 3000 / 4000  
 Max. Delivered Lumen (lm): 960 / 995  
 Nominal Lumen (lm): 1140 / 1200  
 CRI: >80 CRI  
 Lamp Life (hrs): 60000

#### OPTICAL

Optic°: 9 / 28 / 44 / ASY; RGBW - 9 / 28 / 44

#### RATINGS AND CERTIFICATIONS

Certified By: Certified for North American Standards  
 IP rating: IP68  
 IK Rating: IK10  
 Bug Rating: B0 U4 G0  
 Marine Grade: Stainless Steel AISI 316L

PROJECT	_____
TYPE	_____
SPECIFIER	_____
QUANTITY	_____
DATE	_____

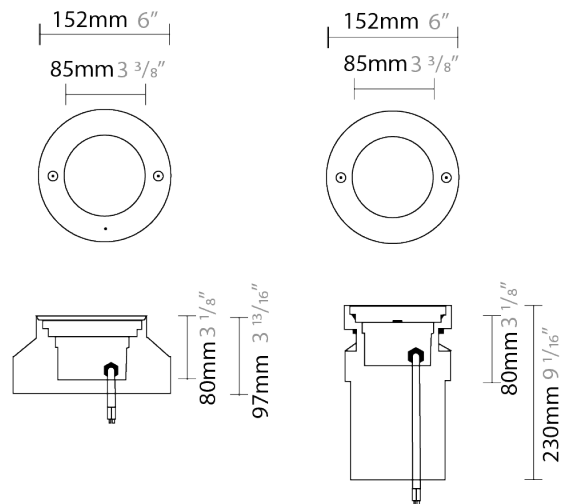

Housing  
L9A08800

Housing  
L9A08800



## MINI FULL INOX RECESSED

E9I576-

PROJECT	_____
TYPE	_____
SPECIFIER	_____
QUANTITY	_____
DATE	_____



## MINI FULL INOX RECESSED

**E91582-** \_\_\_\_\_ - \_\_\_\_\_  
 base number Color Lens  
 Temperature Options

- To build a product code in our configurator select the specify button on the base model # product page
- To build a manual product code on this datasheet choose from the options listed below in blue font and add the suffix to the base model #

### GENERAL

Series: Mini  
 Subseries: Mini Full Inox  
 Brand: Platek  
 Division: Exterior  
 Mounting Type: Recessed  
 Mounting Location: In-Ground  
 Subcategory: Drive Over

### PHYSICAL

Shape: Round  
 Diameter (mm): 152  
 Diameter (in): 6  
 Height (mm): 80  
 Height (in): 3 1/8  
 Light Distribution: Uplight  
 Load Resistance (kg): 2500  
 Load Resistance (lbs): 5511  
 Installation Requirement: Installation in sleeve set in concrete with a 20-30 cm gravel drain bed  
 Screws: A4 stainless steel  
 Diffuser: Extra Clear Flat Tempered Glass - 15mm / 15/32"  
 Fixture Finish: SST  
 Fixture Material: Stainless Steel  
 Cable Details: Supplied with 1 power cable 0.5m in length

### ELECTRICAL

Lamp Type: LED  
 Input Wattage (W): 10  
 Total Output Wattage (W): 8.4  
 Driver Included: No  
 Driver Location: Remote  
 Driver Type: Constant Current - 120 / 277Vac  
 Driver Class: Class 2  
 Input Voltage (V): 120 - 277  
 Constant Current (mA): 500  
 Upon Request: (Not included - see components [IP68 or higher enclosure to be supplied by others]) 0-10Vdc dimming / Phase dimming 120Vac only / Non-dimming

### LED

Number of LEDs: 6  
 Color Temperature (°K): 3000 / 4000  
 Max. Delivered Lumen (lm): 775 - 906 / 805 - 995  
 CRI: >80 CRI  
 Lamp Life (hrs): 60000

### OPTICAL

Optic°: 9 / 28 / 44  
 Beam Angle: Asymmetrical

### RATINGS AND CERTIFICATIONS

Certified By: Certified for North American Standards  
 IP rating: IP68  
 IK Rating: IK10  
 Bug Rating: B0 U4 G0

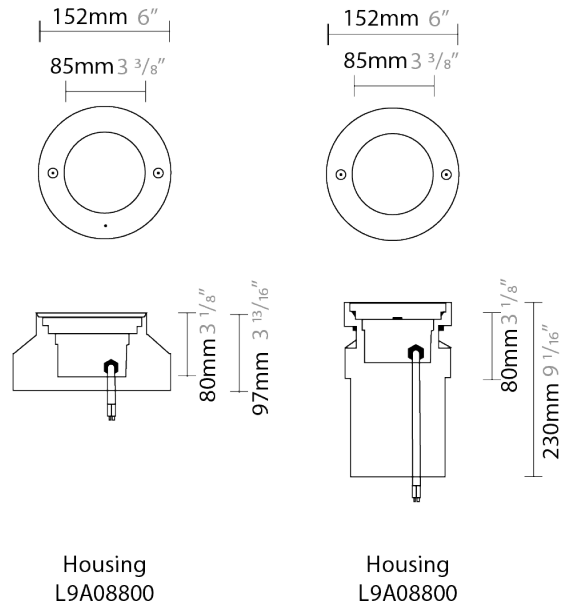
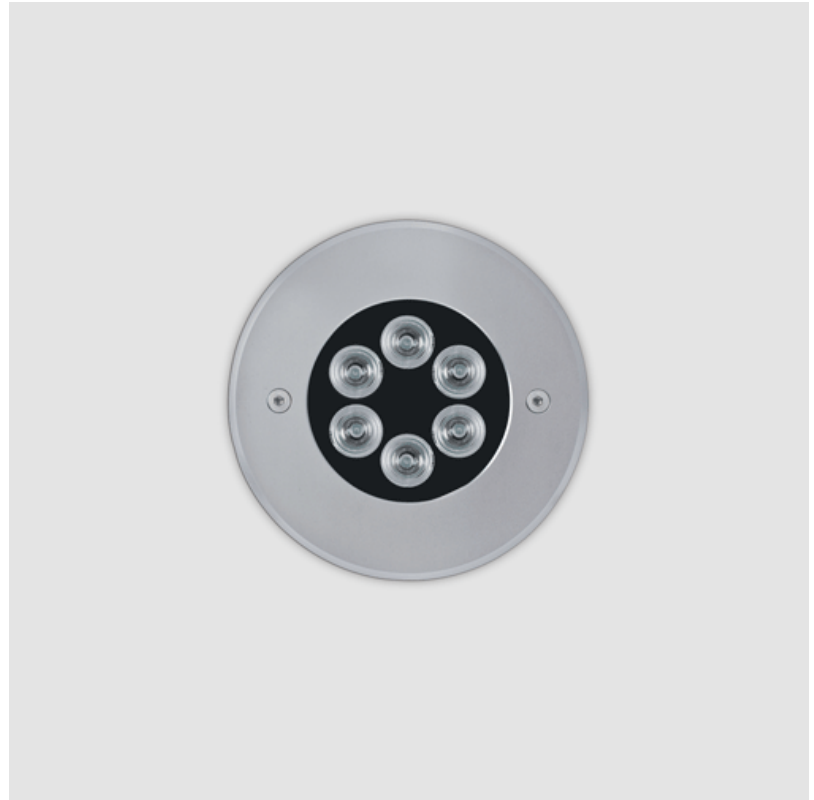

## MINI FULL INOX RECESSED

E9I582-

PROJECT	_____
TYPE	_____
SPECIFIER	_____
QUANTITY	_____
DATE	_____



## MINI SS - DRIVE OVER RECESSED

**E9I619-** \_\_\_\_\_ - \_\_\_\_\_  
 base number    Color    Lens  
                          Temperature    Options

- To build a product code in our configurator select the specify button on the base model # product page
- To build a manual product code on this datasheet choose from the options listed below in blue font and add the suffix to the base model #

### GENERAL

Series: Mini  
 Subseries: Mini SS - Drive Over  
 Brand: Platek  
 Division: Exterior  
 Mounting Type: Recessed  
 Mounting Location: In-Ground  
 Subcategory: Drive Over

### PHYSICAL

Shape: Round  
 Diameter (mm): 152  
 Diameter (in): 6  
 Depth (mm): 80  
 Depth (in): 3 1/8  
 Light Distribution: Uplight  
 Load Resistance (kg): 2500  
 Load Resistance (lbs): 5511  
 Installation Requirement: Installation in sleeve set in concrete with a 20-30 cm gravel drain bed  
 Screws: A4 stainless steel  
 Diffuser: Extra Clear Flat Tempered Glass - 15mm  
 Fixture Finish: SST  
 Fixture Material: Aluminum Die Cast  
 Cable Details: Supplied with 1 power cable 1.5m in length

### ELECTRICAL

Lamp Type: LED  
 Input Wattage (W): 11  
 Total Output Wattage (W): 10 / 11.5 (RGBW)  
 Dimming: 0-10V Dimming / Phase Dimming (120Vac Only) / DMX (RGBW)  
 Control Gear: DMX  
 Driver Included: No  
 Driver Location: Remote  
 Driver Type: White LED - Constant Voltage - 120 / 277Vac  
 Driver Class: Class 2  
 Housing: (Not included - see components) L9A08800 allows for external driver (non-dimming - 120 / 277Vac) / L  
 Input Voltage (V): 120 - 277  
 Output Voltage (V): 24  
 Constant Current (MA): RGBW 500

### LED

Number of LEDs: 6 / RGBW 8  
 Color Temperature (°K): 3000 / 4000 / RGBW  
 Max. Delivered Lumen (lm): 955 / 995  
 Nominal Lumen (lm): 1140 / 1200  
 CRI: >80 CRI  
 Lamp Life (hrs): 60000

### OPTICAL

Optic: 9 / 28 / 44 / Asymmetrical

### RATINGS AND CERTIFICATIONS

Certified By: Certified for North American Standards  
 IP rating: IP68  
 IK Rating: IK10

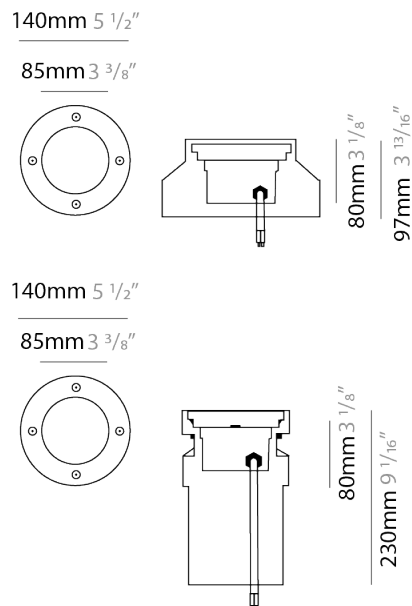

## MINI SS - DRIVE OVER RECESSED

E9I619-

PROJECT

TYPE

SPECIFIER

QUANTITY

DATE

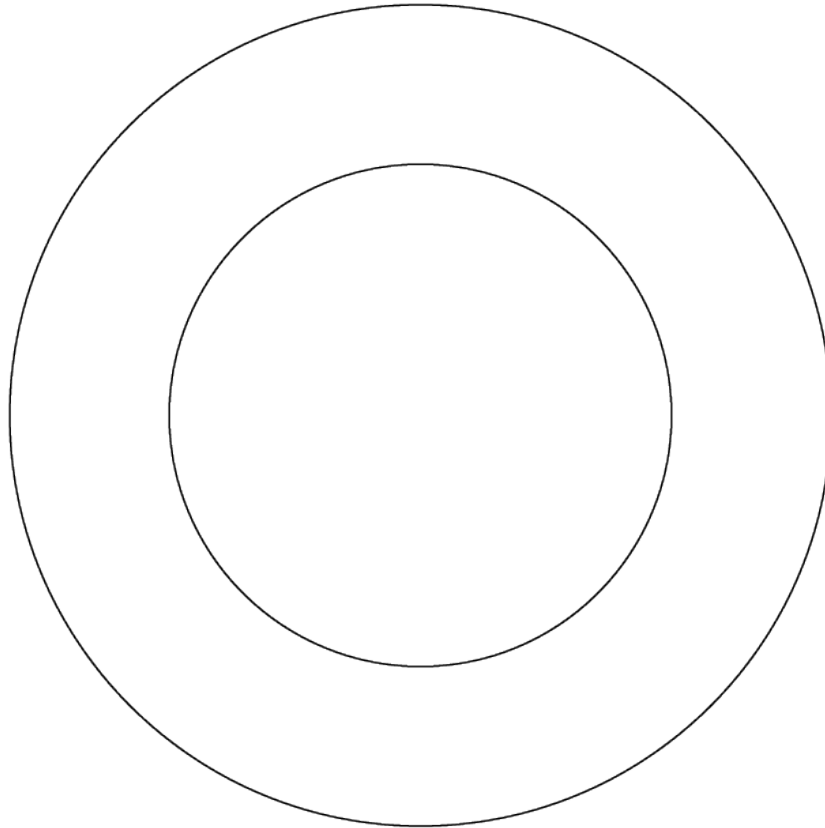



PROJECT	_____
TYPE	_____
SPECIFIER	_____
QUANTITY	_____
DATE	_____

## MINI CEILING RECESSED

### E9Q023-

base number    Color    Lens  
 Temperature    Options

- To build a product code in our configurator select the specify button on the base model # product page
- To build a manual product code on this datasheet choose from the options listed below in blue font and add the suffix to the base model #

#### GENERAL

Series: Mini  
 Subseries: Mini Ceiling  
 Brand: Platek  
 Division: Exterior  
 Mounting Type: Recessed  
 Mounting Location: Ceiling  
 Subcategory: Downlight

#### PHYSICAL

Shape: Round  
 Diameter (mm): 152  
 Diameter (in): 6  
 Height (mm): 80  
 Height (in): 3 1/8  
 Ceiling Thickness (mm): 10 - 20  
 Ceiling Thickness (in): 3/8 - 13/16  
 Light Distribution: Direct  
 Diffuser: Clear tempered glass  
 Fixture Finish: SST  
 Fixture Material: Aluminum Die Cast  
 Cut-out Measurements: 140mm / 5 1/2" diameter

#### ELECTRICAL

Lamp Type: LED  
 Input Wattage (W): 10.5  
 Total Output Wattage (W): 9  
 Dimming: Tri-Mode (Non-Dimming and Phase Dimming (120Vac only) and 0-10V Dimming)  
 Driver Included: No  
 Driver Location: Remote  
 Driver Type: Constant Current - 120 / 277Vac  
 Driver Class: Class 2  
 Input Voltage (V): 120 - 277  
 Constant Current (MA): 500

#### LED

Number of LEDs: 6  
 Color Temperature (°K): 3000 / 4000  
 Max. Delivered Lumen (lm): 960 / 995  
 Nominal Lumen (lm): 1140 / 1200  
 CRI: >80 CRI  
 Lamp Life (hrs): 60000

#### OPTICAL

Optic: 9 / 28 / 44  
 Adjustability: Tilt ±5°

#### RATINGS AND CERTIFICATIONS

Certified By: Certified for North American Standards  
 IP rating: IP68  
 IK Rating: IK10

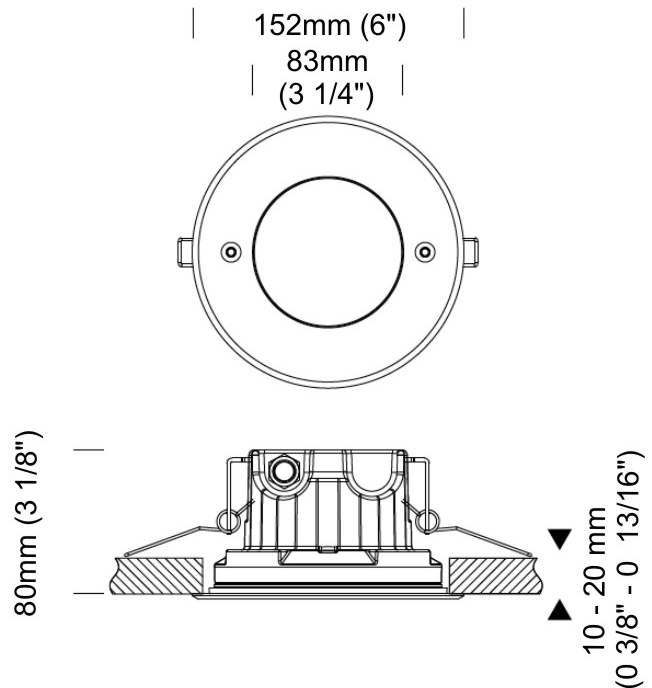

## MINI CEILING RECESSED

E9Q023-

PROJECT
TYPE
SPECIFIER
QUANTITY
DATE

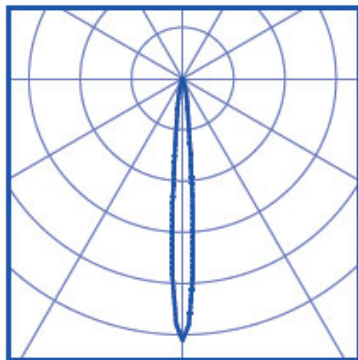

10° spot  
20443 cd/klm

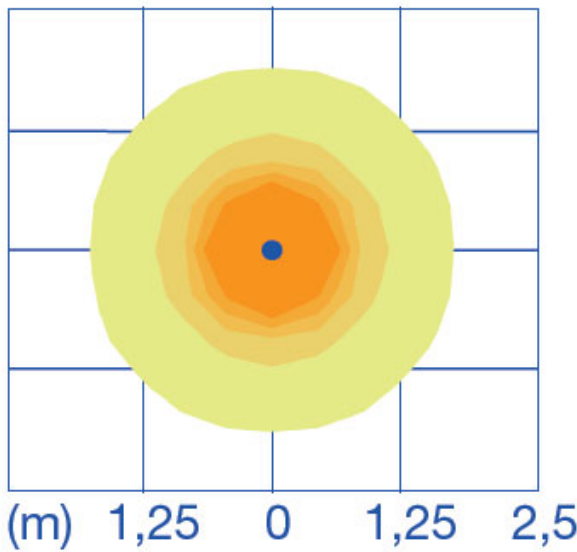

- 130 lux
- 100 lux
- 70 lux
- 40 lux
- 10 lux

H. 6m  
3000K  
@500mA



## MINI COLOR FINISH CHART

PROJECT

TYPE

SPECIFIER

QUANTITY

DATE

### Fixture Finish

Stainless Steel Inox - SST



**Digital:** Not all screens are calibrated the same, and therefore, colors will appear differently between screens.

**Physical:** When texture is involved, there will be variations in color, character and tone within a product series and between product families.













PROJECT	
TYPE	
SPECIFIER	
QUANTITY	
DATE	











### LEGEND

 floor-mounted	 pivotable	 special LED (upon request) RGB, RGBW, tunable, gold+, meat+, art+, fashion+
 wall and ceiling: recessed and surface mounted	 rotating	 warm dim / natural dimming LED
 ceiling-mounted and wall-mounted	 illuminate tilted	 rechargeable battery powered
 wall-mounted	 color of suspension cable	 fixture with natural vivid LED (upon request)
 omni-directional light distribution	 length of suspension cable	 color rendering index
 direct light distribution	 reflector degree selection	 color temperature
 direct/indirect light distribution	 super spot	 lumen (luminous flux)
 indirect light distribution	 lens	 efficacy (lumens per watt)
 asymmetric light distribution	 lens pack	 Unified Glare Rating (UGR) range from 5-40
 aura light distribution	 shine ring	 marine grade (AISI 316 stainless steel)
 round wall or ceiling cut-out	 integrated shine ring with diffuser	 walk on
 square wall or ceiling cut-out	 free individual colors 01-29	 drive on
 the supplied jig specifies the cutout dimensions	 individual colors: 00 (free of charge), 01-25 (extra charge)	 Dark Sky Compliance
 minimum distance (meters) lamp - object	 luminaire part to be colored (F1)	 Americans with Disabilities Act (less than 4" off the wall located between 27"-84" from floor)
 recessed depth	 luminaire part to be colored (F2)	 lamp protected against explosion
 ceiling thickness in mm	 luminaire part to be colored (F3)	 blown glass using traditional methods by master glass blower
 ceiling thickness selection	 luminaire part to be colored (F4)	 acoustic material
 dimmable DP (phase), DV (0-10V), DD (dali), DS (step-dim)	 luminaire part to be colored (F5)	 protection class I, protection insulation
 included or excluded LED driver/transformer/control gear	 color of 3-circuit adaptor	 protection class II, protection insulation
 separately switchable	 indirect diffuser	 ETL Certified to UL and CSA Standards
 sensor	 direct diffuser	 UL Certified to UL and CSA Standards
 remote control	 ball-proof (upon request)	 CSA Certified to UL and CSA Standards
 available upon request	 accessory	 Certified for North American Standards

### IP RATING

 IP20	protected against ingress of solid bodies greater than 12.5mm (finger)
 IP33	protected against ingress of solid bodies greater than 2.5mm protected against sprays of water up to 60 degrees from the vertical (rain)
 IP40	protected against ingress of solid bodies greater than 1mm (wire) no protection against the ingress of moisture
 IP43	protected against ingress of solid bodies greater than 1mm (wire) protected against sprays of water up to 60 degrees from the vertical (rain)
 IP44	protected against ingress of solid bodies greater than 1mm (wire) protected against water splashed from all directions
 IP54	protected against limited ingress of dust (wet rooms/covered outdoor areas) protected against water splashed from all directions
 IP65	protected against ingress of dust protected against jets of water
 IP66	protected against ingress of dust protected against powerful jets of water or heavy seas
 IP67	protected against ingress of dust protected against immersion of water between 15cm - 1m for 30 minutes
 IP68	protected against ingress of dust protected against immersion of water under pressure for long periods

### IK RATING

 IK01	protected against 0.14 joules impact (equivalent to 0.25kg mass dropped from 56mm above the surface)
 IK02	protected against 0.2 joules impact (equivalent to 0.25kg mass dropped from 80mm above the surface)
 IK03	protected against 0.35 joules impact (equivalent to 0.25kg mass dropped from 140mm above the surface)
 IK04	protected against 0.5 joules impact (equivalent to 0.25kg mass dropped from 200mm above the surface)
 IK05	protected against 0.7 joules impact (equivalent to 0.25kg mass dropped from 280mm above the surface)
 IK06	protected against 1 joules impact (equivalent to 0.25kg mass dropped from 400mm above the surface)
 IK07	protected against 2 joules impact (equivalent to 0.5kg mass dropped from 400mm above the surface)
 IK08	protected against 5 joules impact (equivalent to 1.7kg mass dropped from 300mm above the surface)
 IK09	protected against 10 joules impact (equivalent to 5.0kg mass dropped from 200mm above the surface)
 IK10	protected against 20 joules impact (equivalent to 5.0kg mass dropped from 400mm above the surface)